

# Installation North America only

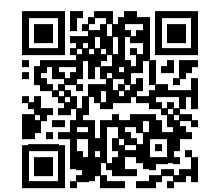
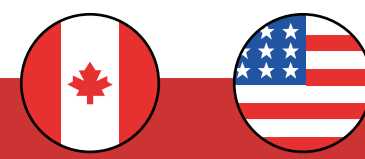

For full installation videos of screwing or gluing the panels scan QR code or visit fibosystemusa.com

## HOW TO SEAL FIBO WALL PANELS

For watertight system, apply Fibo Seal as shown beneath. All cutting surfaces must be sealed, also when drilling holes for pipe penetration. Incorrect installation will void your warranty. Use Fibo Clean and Fibo Wipes to remove excessive sealant. Film from cleaning accessories shall be removed immediately from the panels.

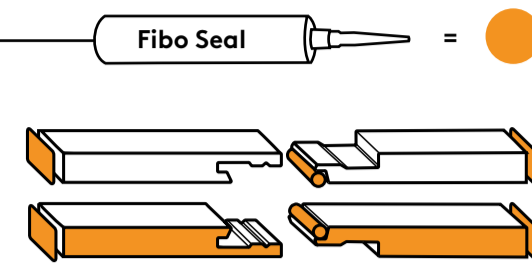

## 1 CHOOSE PREFERRED BACKWALL



Make sure the backwall is level and the corners are straight 90°. For uneven walls we recommend using OSB Strips and if necessary extra shims to even out.

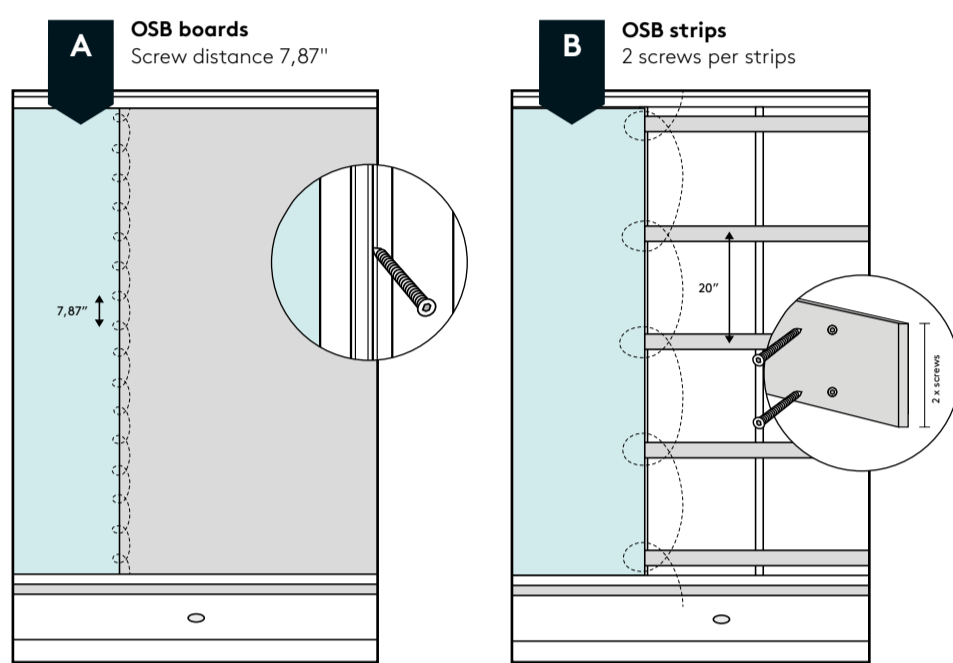

- WARNING:** This product can expose you to chemicals including formaldehyde and acetaldehyde, which is known to the State of California to cause cancer. For more information, go to [www.P65Warnings.ca.gov](http://www.P65Warnings.ca.gov)
- WARNING: Fumes Hazard:** The fumes from the Fibo Clean used by the installer can be harmful if used in an unventilated room. Always work in a well-ventilated area. To keep the area well-ventilated, open windows and use exhaust fans. If adequate ventilation is not achievable or practical, use respiratory protective equipment.



## 2 NICHES AND FAUCETS

### Faucet

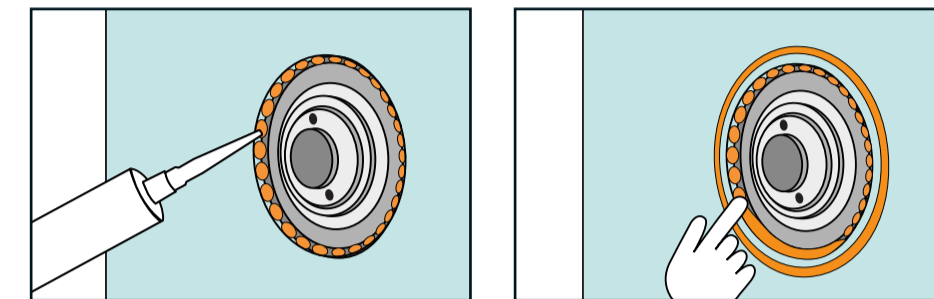

### Niche

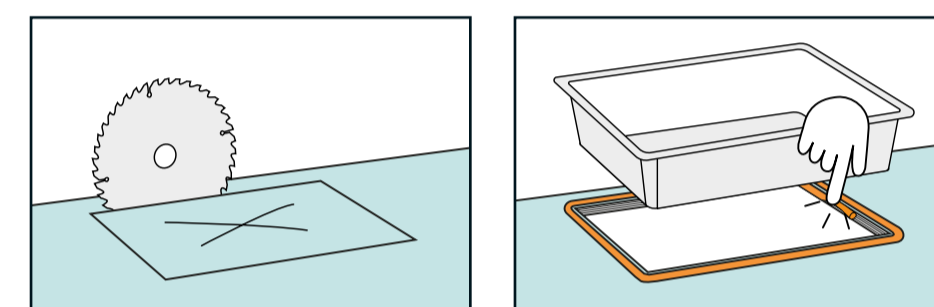

# Fibo

# Wall panel Veggpanel

READ BEFORE OPENING PACKAGE!

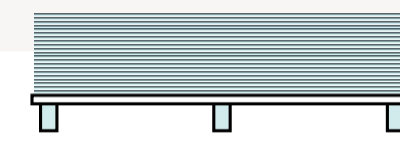

**Storage | Lagring**  
Keep panels dry stored and flat in package until installation.

Lagre panelene tørt og liggende i emballasjen frem til monteringen.



**Min. 72 hours | Min. 72 timer**  
Store panels in package in room conditions for at least 72 hour acclimatization (longer if they have been kept in a cold area). Humidity in the room must be above 50% during installation.

Akklimatiser emballerte paneler i romtemperatur i minst 72 timer (mer hvis de har vært på kaldt lager). Luftfuktigheten i rommet må være mer enn 50% både under og etter monteringen.

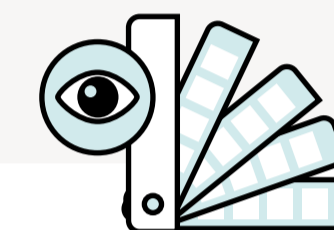

**Visual control | Visuell kontroll**  
Colourmatch and check for flaws before installation.  
Kontroller farge og sjekk for andre feil før monteringen.

## 3 ALCOVE - STANDARD WALLPANEL

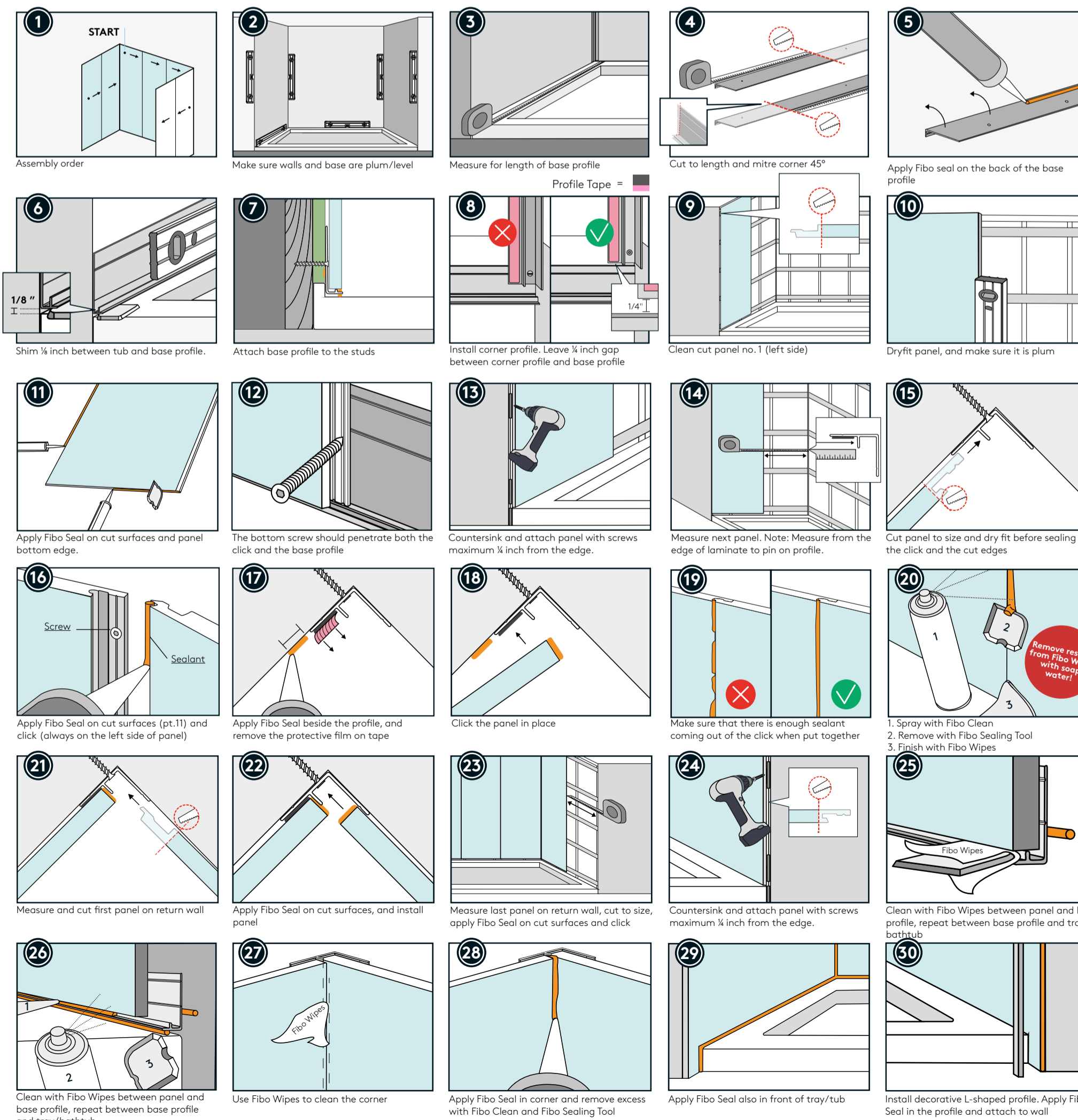

## Walls built for life

To ensure that your walls are durable and will last for decades, Fibo wall panels are made from a plywood core layered between a balancing layer and a decorative high pressure laminate that is easy to clean and maintain. Fibo Aqualock makes the installation easy and provide a consistent result. Please visit our webpage for cleaning and maintenance guidance of the system

For å sikre holdbarhet på dine vegger i flere tiår, er Fibo veggpanel produsert med en kjerne av kryssfiner mellom balanselaminat i bakkant og et dekorativt høytrykkslaminat i front og som er enkelt å rengjøre og vedlikeholde. Fibo Aqualock gir enkel monteringen og et varig resultat. Besøk nettsiden for instruksjon om Drift, Vedlikehold og Rengjøring (FDV)



Installation videos in both Norwegian and English



Inspiration and installation videos at [fibosystem.com](http://fibosystem.com) / E-mail: [info@fibosystem.com](mailto:info@fibosystem.com)  
Inspirasjon og monteringsfilmer på [fibo.no](http://fibo.no)

011144 101 001

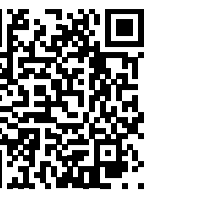

Installation videos in both Norwegian and English

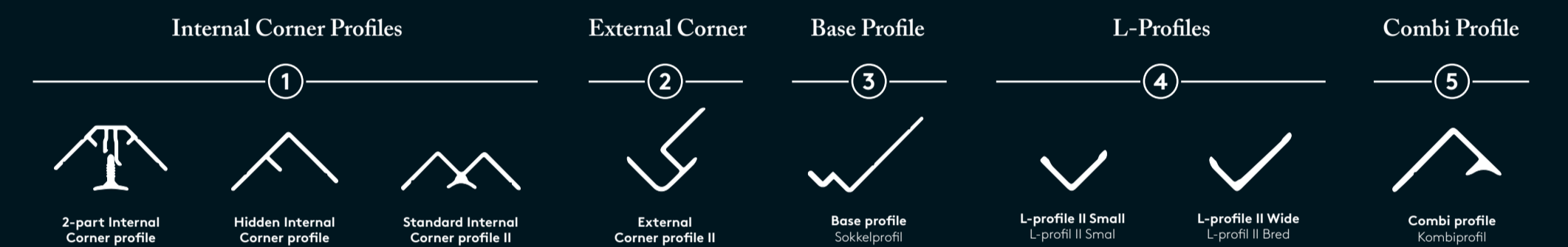
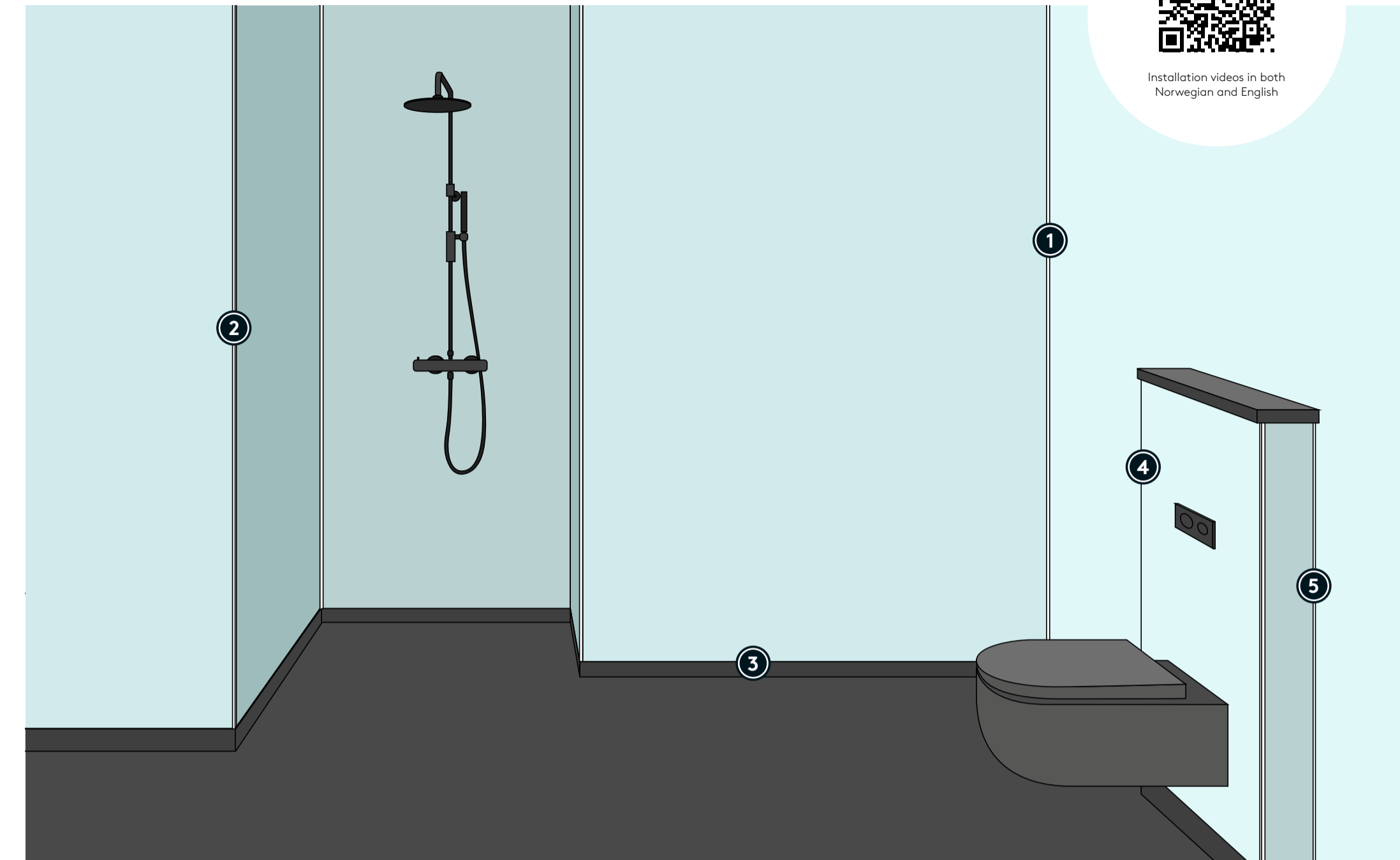

Fibo replaces vapor barrier when all joints are sealed.  
Fibo erstatter dampspærre på yttervegg når alle overganger er forsejlet.



Remove residue from Fibo Wipes immediately with soap water! Vask bort rester fra Fibo Wipes umiddelbart med såpevann!

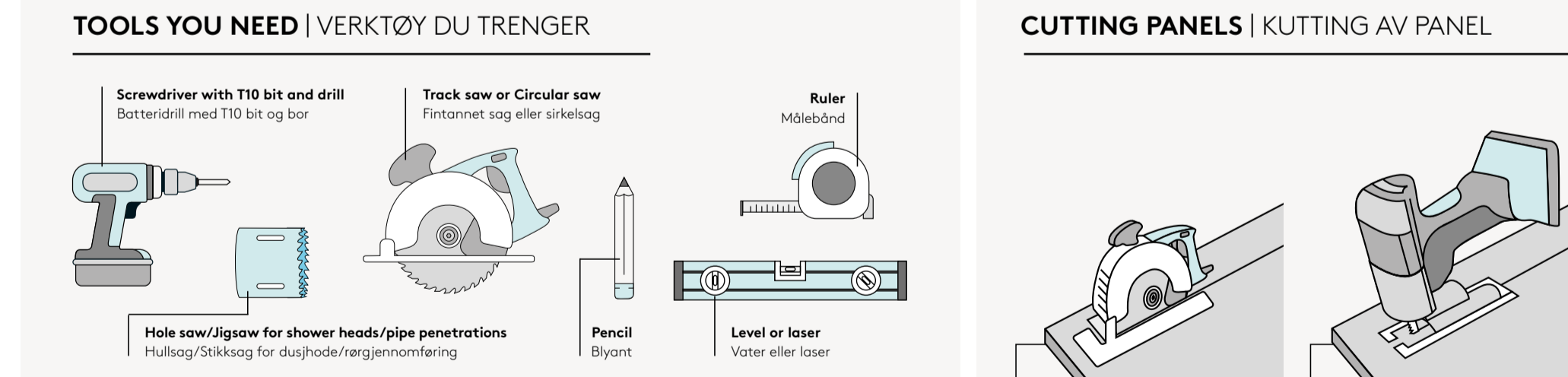

**WARNING: Power tools must be used with caution to prevent damaged panels.**  
ADVARSEL: Verktøy må håndteres med forsiktighet for å unngå skade på paneler.

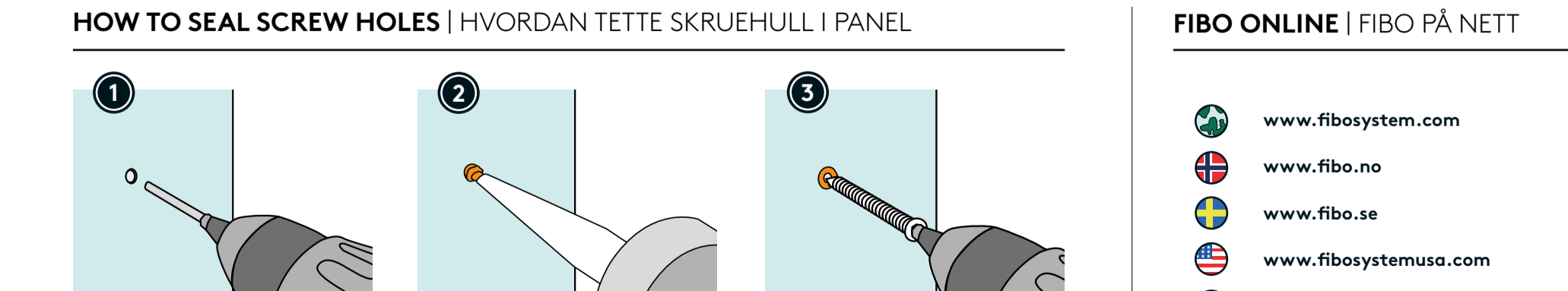

**CLEANING & MAINTENANCE | RENGJØRING & VEDLIKEHOLD**  
Extend the life of the sealant by correct cleaning, in accordance with "Cleaning & Maintenance" documents at fibosystem.com. In particular, sealant in the base profile and hidden internal corner profile should be cleaned regularly. If the sealant becomes brittle or damaged over time, it must be treated immediately.  
Føket fugemassens levetid ved korrekt rengjøring. I henhold til FDV på fibo.no. Spesielt fugemasse i sokkelprofil og skjult innvendig hjørne for fuging bør rengjøres regelmessig. Hvis fugemasse blir sprø eller skadet over tid, må den behandles umiddelbart.  
A moist Fibo Sponge can be used on particularly difficult surfaces stains. Follow the instructions for use on the product's packaging.  
Fuktet melaminvamp (Fibo Sponge) kan brukes på særlig vanskelige flekker. Følg bruksanvisning på produktets emballasje.

- FIBO ONLINE | FIBO PÅ NETT**
- [www.fibosystem.com](http://www.fibosystem.com)
  - [www.fibo.no](http://www.fibo.no)
  - [www.fibo.se](http://www.fibo.se)
  - [www.fibosystemusa.com](http://www.fibosystemusa.com)
  - [www.fibo.co.uk](http://www.fibo.co.uk)
  - [www.fibosystem.fi](http://www.fibosystem.fi)
  - [www.fibosystem.dk](http://www.fibosystem.dk)

For more information and warranty conditions. For mer informasjon og garantibestemmelser.



# Installation steps 1-5

## Monteringssteg 1-5

FIBO SEAL MUST BE USED IN ALL PANEL JOINTINGS (INCL. DRY AREA) TO REDUCE RISK OF JOINT OPENING OVER TIME.

FIBO SEAL SKAL BENYTTES I ALLE PANELSKJØTER (INKL. TØRRE SONER) FOR Å REDUSERE RISIKO FOR AT TØRRESPREKKER OPPSTÅR OVER TID.

FOR NORTH AMERICA SEE LAST PAGE!

### HOW TO PRESEAL AND SEAL FIBO

For watertight system, apply Fibo Seal as shown beneath. All cutting surfaces and bottom edge of panel must be sealed, also when drilling holes for pipe penetration. Incorrect installation according to this installation manual will void your warranty and terms of claim. Use Fibo Clean and Fibo Wipes to remove excessive sealant. Film from cleaning accessories shall be removed immediately from panel surface.

### HVORDAN FORSEGLE OG FUGE FIBO

For vannett system, påfør Fibo Seal som vist under. Alle kuttflater og kryssfiner i bunn av panel skal forsegles - også ved hulltakning til rørgjennomføring. Ved mangelfull montering iht. denne monteringsanvisningen bortfaller garanti og reklamasjonsrett. Bruk Fibo Clean og Fibo Wipes for å fjerne overflødig fugemasse. Film fra rengjøringsstøtter skal fjernes umiddelbart fra panelene.

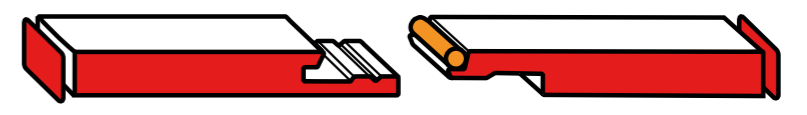

Fibo Seal = Presealing panel cut surfaces  
Fibo Seal = Sealing joints

## 1 BACKWALL OPTIONS VELG RIKTIG BAKVEGG

Extra support in backwall must be used if heavy objects such as cabinets, toilets, shower seats, support handles or similar is to be installed. Flatness tolerance: Maximum flatness deviation of +/-2 mm/2 meters. There is no need for extra membrane behind our wall panels.

Benytt ekstra støtte i bakvegg dersom det skal monteres tunge gjenstander som skap, toalett, dusjstue, støttehåndtak eller lignende. Planhetetoleranse: Maksimalt planhetssavvik på +/-2 mm/2 meter. Det er ikke behov for dampsperre eller membran bak veggpanelene.

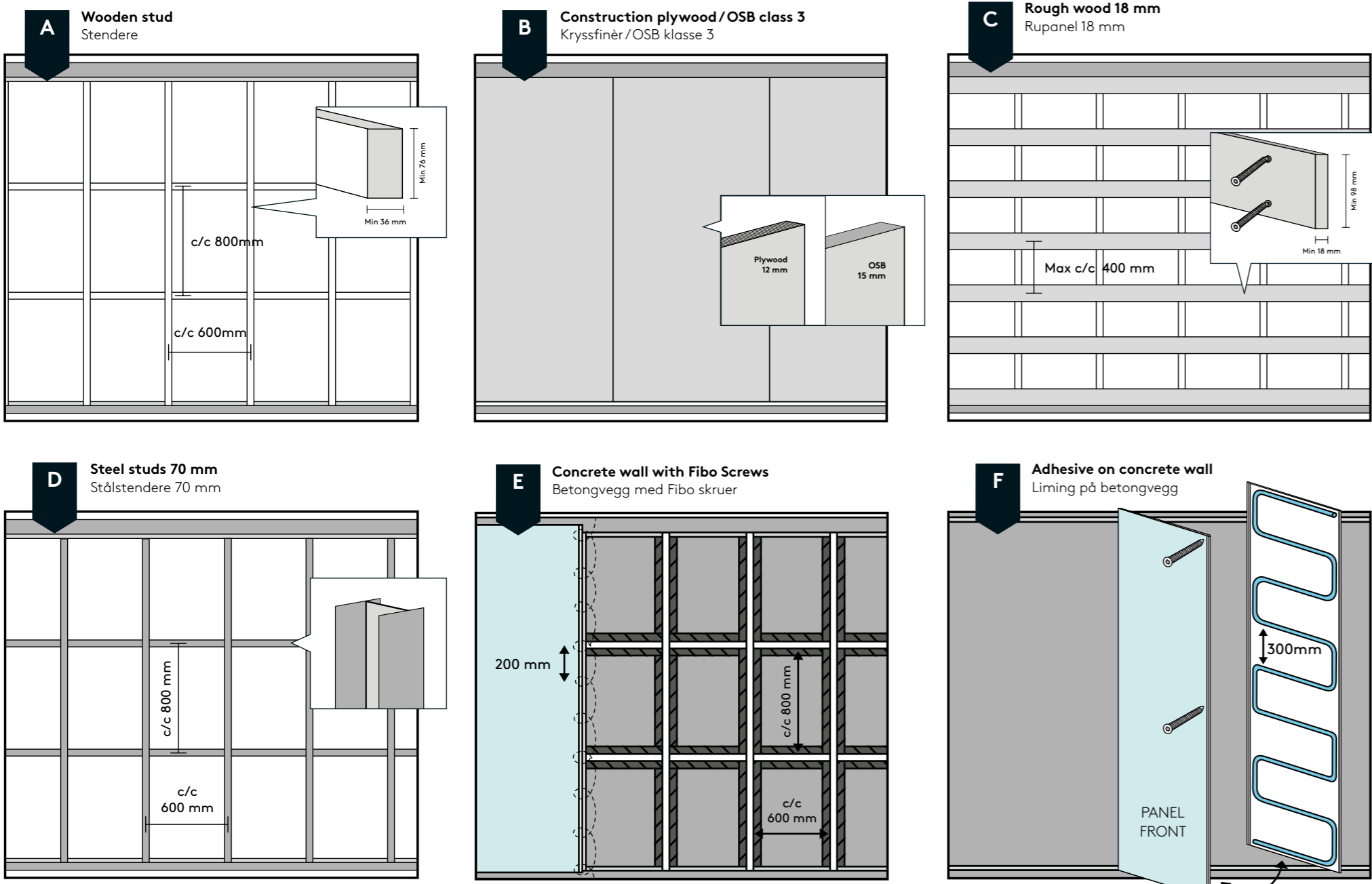

When installed on concrete or brick walls with screws, the panels shall be fixed to vertical and horizontal battens with dimensions min. 23 mm x 48 mm. The battens shall be installed c/c 0,8 m with the wide side flat, with a capillary abstracting layer between the inner battens and the concrete wall.

Ved montering på betong- eller teglvegger med skruer skal panelene festes til vertikale og horisontale lekter med dimensjoner min. 23 mm x 48 mm. Lekterne skal monteres c/c 0,8 m med bred side mot vegg, med kapillært bindende lag mellom de inneste lekterne og betongveggen.

Fibo Adhesive = 6 mm

When gluing panel to a concrete wall, make sure the back wall is dry (RH<85%/CM<2%), even and dust free. Place panel into position and secure with pressure. Make sure to screw the first panel as shown. In the UK it is allowed to glue on tiles. Check national building regulations for more.

Fibo Seal in combination with screws, or glue with initial grab. Make sure to screw the first panel as shown.

Ved liming av panel til vegg av betong, sørg for at veggen er tørr (RH<85%/CM<2%), jevn og rengjort. Husk skruer på første panel - se figur.

## 2 SOLUTIONS FOR APERTURES FOR PIPES LØSNINGER FOR RØRGJENNOMFØRING

Cutting surfaces must be sealed when drilling holes for pipe penetration. For complete installation guidance, follow the wall box producer's instructions. The ones illustrated are EAD 030437-00-0503 approved systems. Approval for PP- and copper pipes is documented through SINTEF Technical Approval Z289.

Kuttflater skal forsegles ved hulltakning til rørgjennomføring. For fullstendig monteringsanvisning se EAD 030437-00-0503 godkjente løsninger, følg veggkassens produsentens anvisninger. Godkjenning av PP- og kobberrør er dokumentert i SINTEF Teknisk Godkjenning Z289.

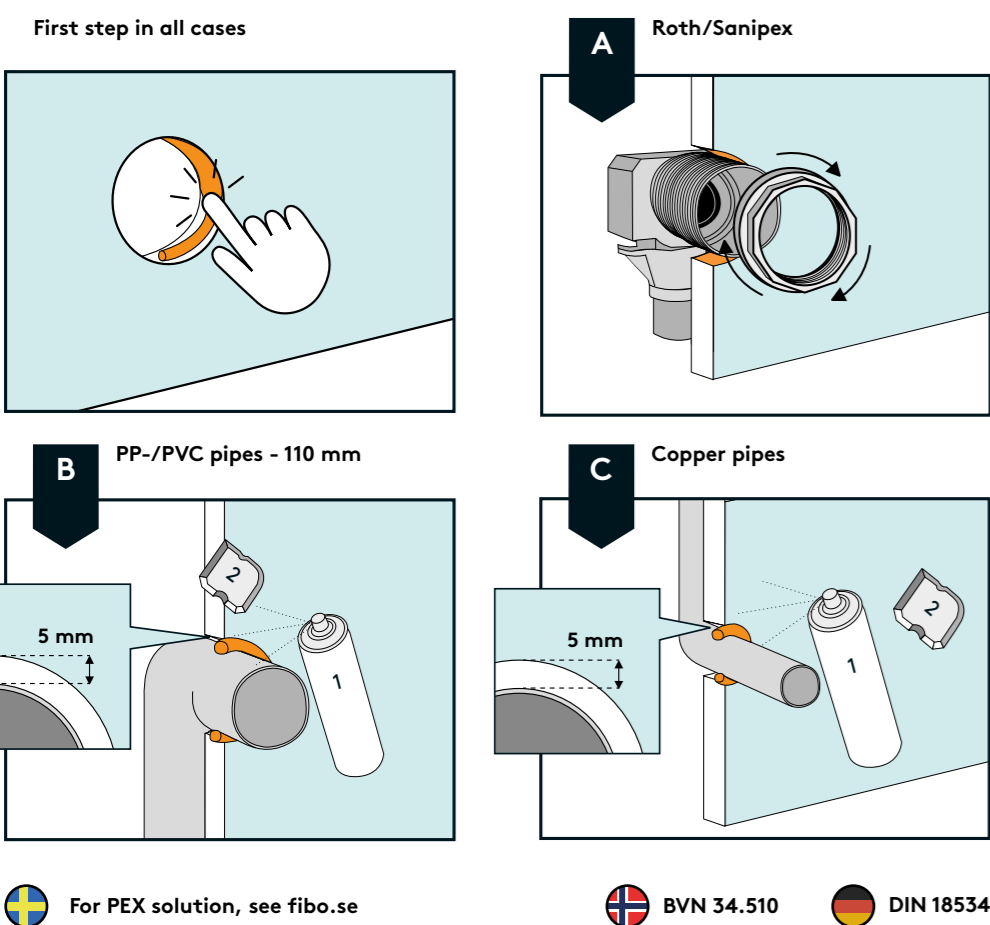

For PEX solution, see fibose. BVN 34.510 DIN 18534

## 3 SEALING FINISH, STACKING PROFILE AND EXTERNAL CORNER PROFILE AVSLUTNING MOT TAK, SKJØTEPROFIL OG UTVENDIG HJØRNEPROFIL

Fibo Seal = Not available in the UK

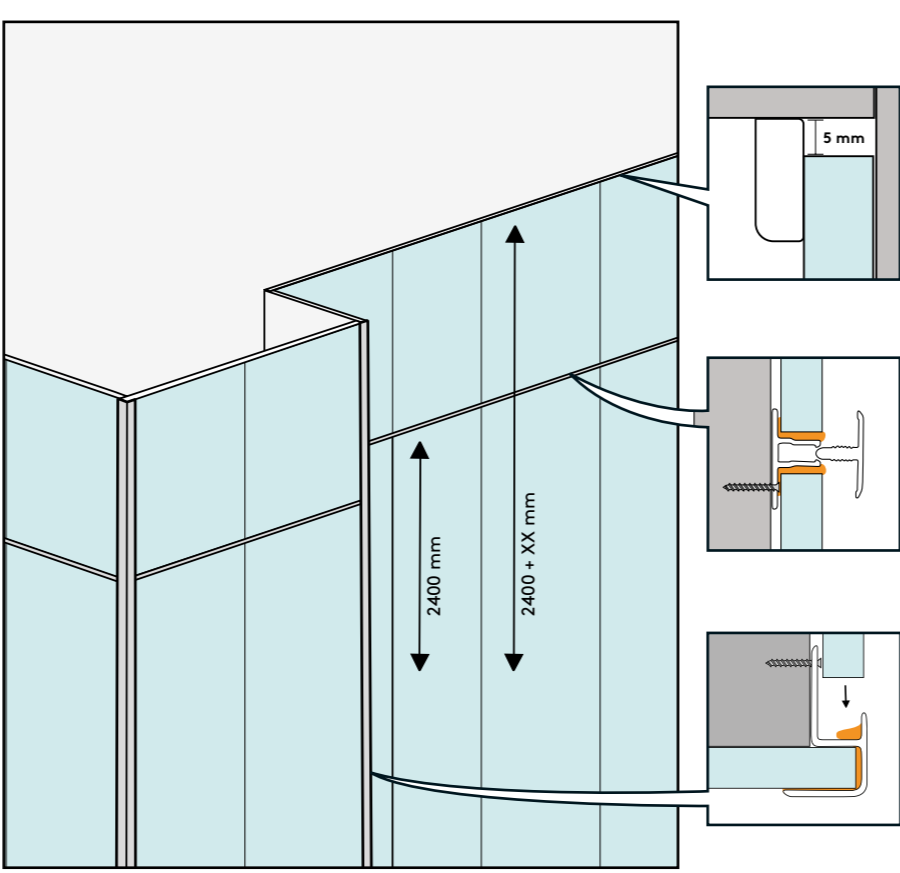

## 4 CHOOSE TRANSITION TO FLOOR MEMBRANE AVSLUTNING MOT GULVMEMBRAN

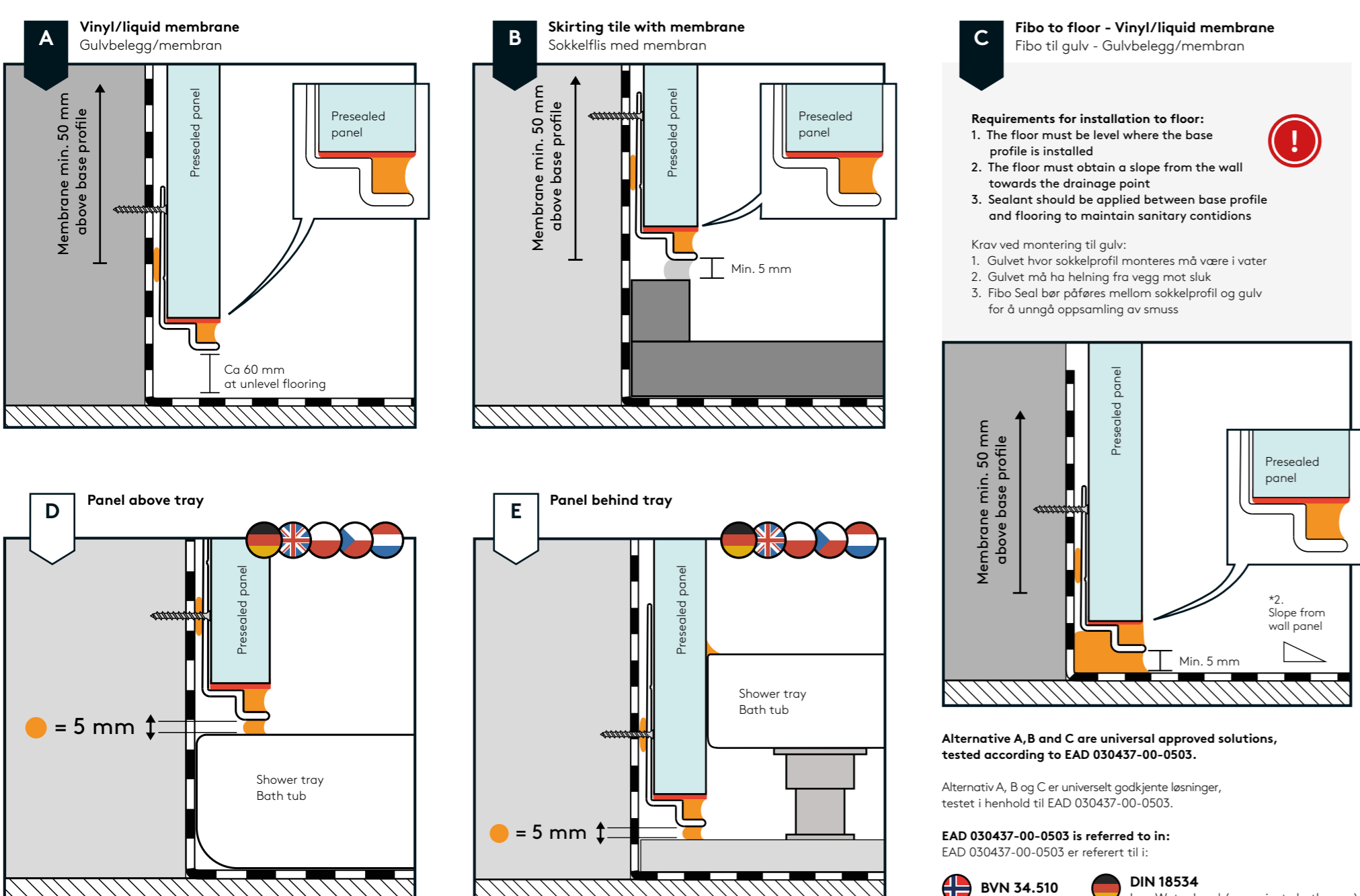

Requirements for installation to floor:  
1. The floor must be level where the base profile is installed.  
2. The floor must obtain a slope from the wall towards the drainage point.  
3. Sealant should be applied between base profile and flooring to maintain sanitary conditions.

Krav ved montering til gulv:  
1. Gulvett hvor sokkelprofil monteres må være i vater.  
2. Gulvet må ha helning fra vegg mot sluk.  
3. Fibo Seal bør påføres mellom sokkelprofil og gulv for å unngå oppsamling av smuss.

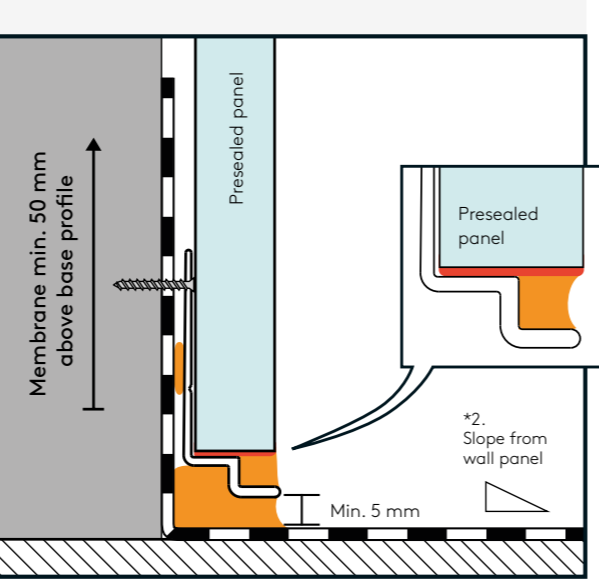

Alternative A, B and C are universal approved solutions, tested according to EAD 030437-00-0503.

Alternativ A, B og C er universelt godkjente løsninger, testet i henhold til EAD 030437-00-0503.

EAD 030437-00-0503 is referred to in: BVN 34.510 DIN 18534

Low Water Load (e.g. private bathroom)

## 5 CHOOSE PREFERRED CORNER PROFILE A, B OR C VELG HJØRNEPROFIL A, B ELLER C

### A 2-PART INTERNAL CORNER PROFILE\* 2-DELT INNVEDIG HJØRNEPROFIL

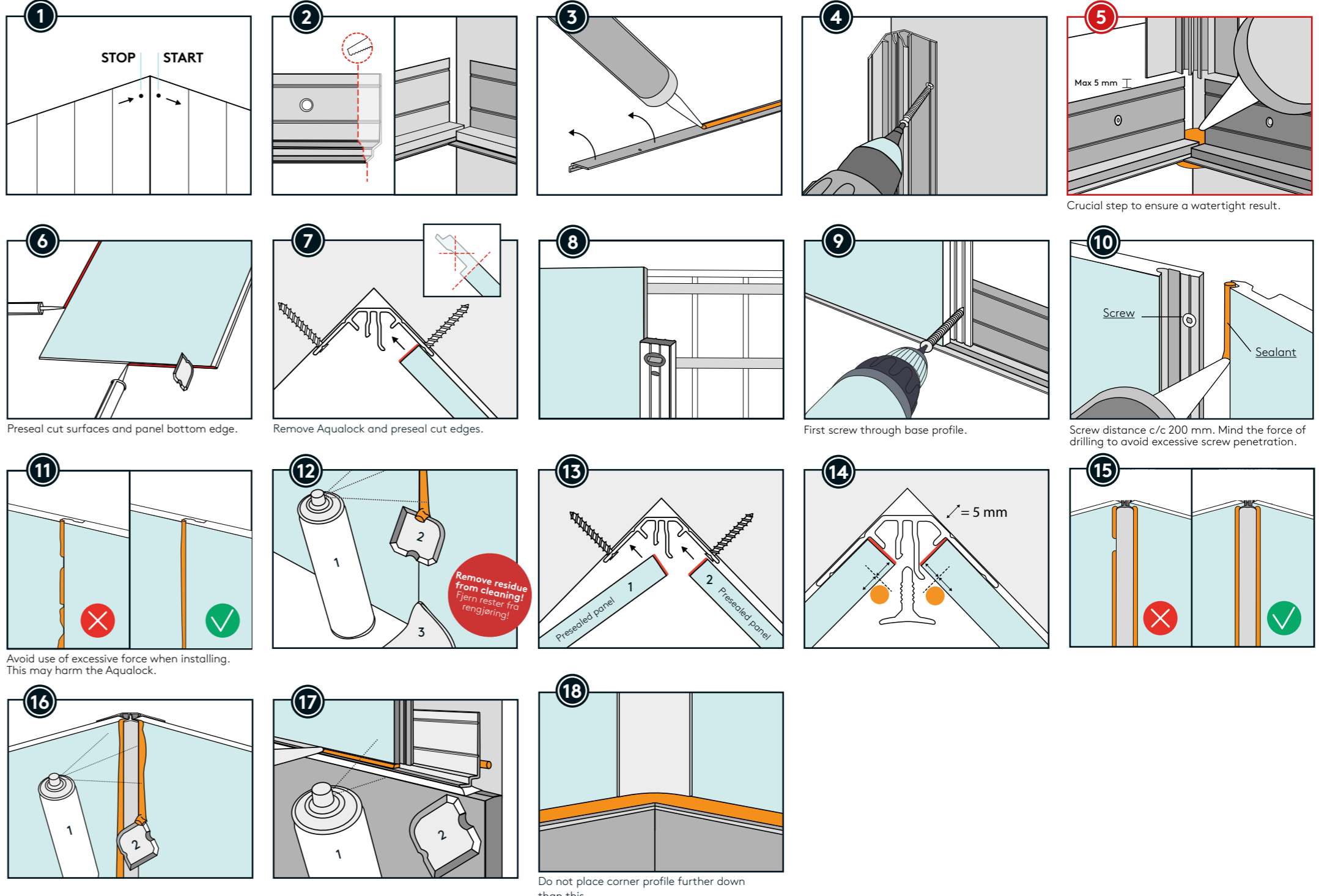

### B HIDDEN INTERNAL CORNER PROFILE SKJULT HJØRNEPROFIL

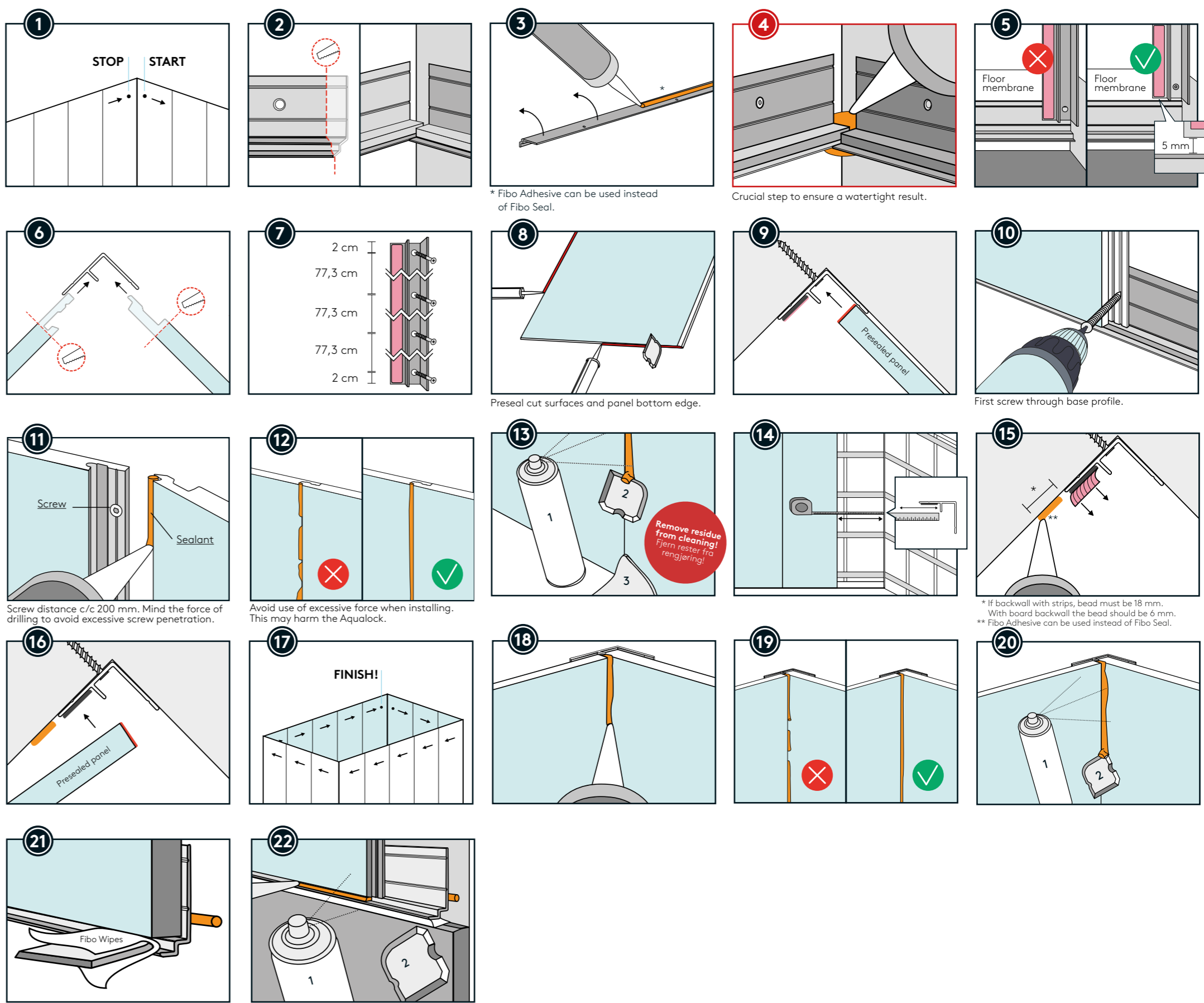

### C STANDARD INTERNAL CORNER PROFILE STANDARD INNVEDIG HJØRNEPROFIL

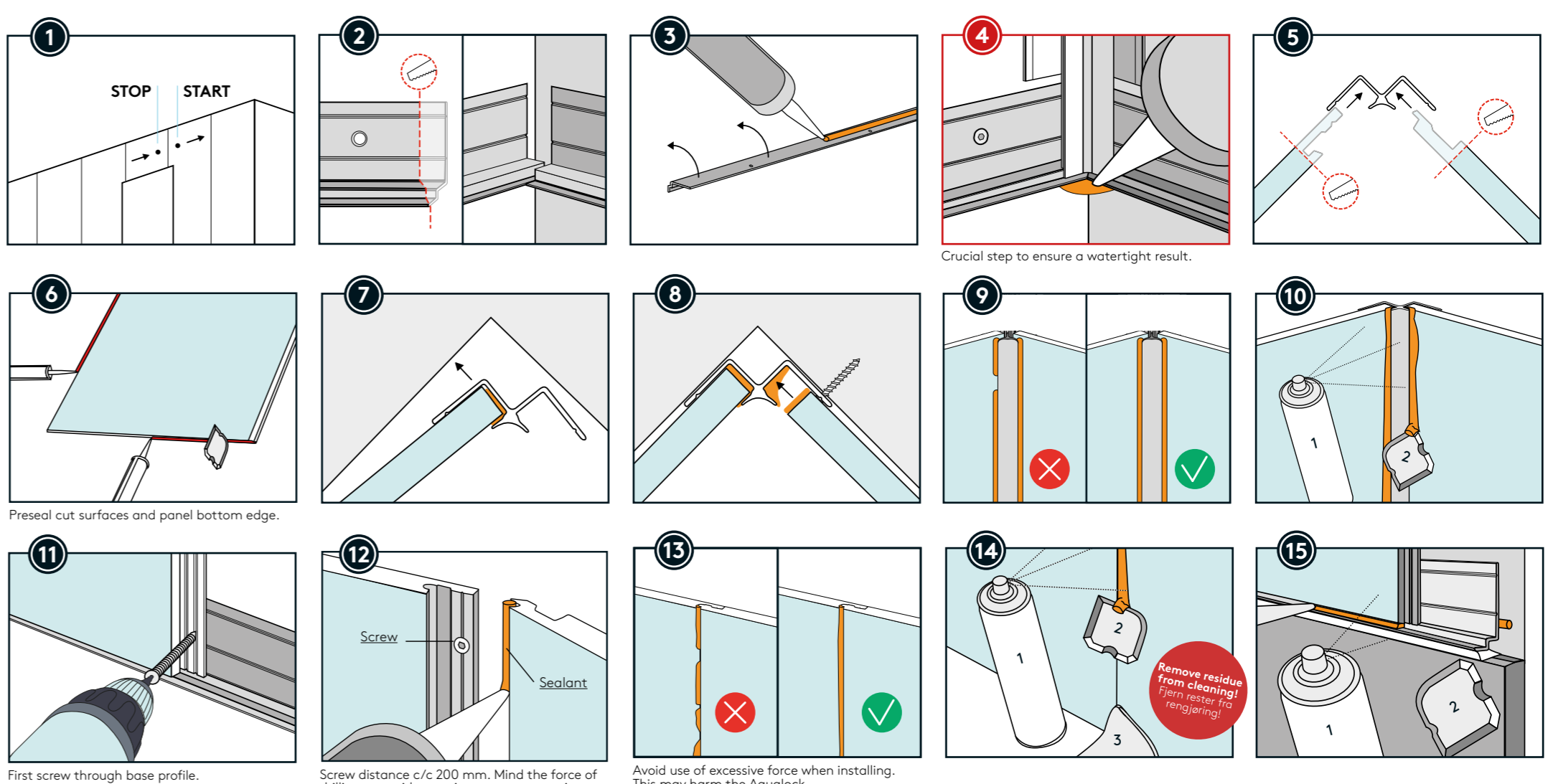

REMEMBER! Always clean panels with neutral detergent after installation. This is important to achieve the best result. Extra difficult spots can be removed with Fibo Clean together with Fibo-Sponge. HUSK! Vask alltid panelene med nøytralt vaskemiddel etter montering. Dette er viktig for best mulig sluttresultat. Ekstra vanskelige flekker kan fjernes med Fibo Clean og Fibo-Svamp.

NB: It is recommended to use a cradling movement back and forth when clicking the panels together to ensure a good joining of the Aqualock. Using Fibo Grip will give increased control during joining. If necessary, you can carefully top the nail lip on the right side of the panel with the Fibo Tapping Tool to ensure that the panel is completely locked. NB: Det anbefales bruk av vuggende bevegelse når man klikker panelene sammen for å sikre en god sammenføyning av Aqualock. Bruk av Fibo Grip vil gi økt kontroll under sammenføyning. Ved behov kan man slå forsiktig med spikerleppen på høyre side av panelet med Fibo Tapping Tool for å sikre at panelet er helt i lås.